

## Single sink - Stainless Steel

---

38 400 003



- under-mounted
- 400 x 400 mm
- sink depth 175 mm
- suitable for base units 450 mm
- radius 12 mm

**Drain and overflow set not included in the scope of supply. See Required miscellaneous.**

Drain and overflow set not included in the scope of supply. See Required miscellaneous.

### Required miscellaneous

---



**Pop-up waste and overflow with electronic control - Stainless Steel** 10 410 003-85  
 • 3½" electronic drain valve (TouchFlow)

### Required miscellaneous

---



**Pop-up waste and overflow closable by hand - Stainless Steel** 10 400 003-85  
 • 3½" drain valve closable by hand

### Required miscellaneous

---



**Pop-up waste and overflow with knob - Stainless Steel** 10 405 003-85  
 • 3½" strainer waste valve

**Single sink - Stainless Steel**

38 400 003

mm [inches]

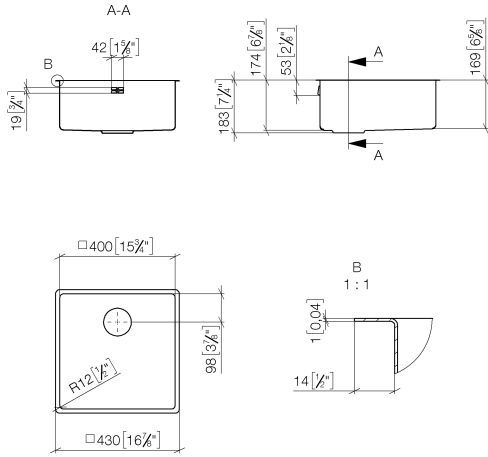

**Single sink - Stainless Steel**

38 400 003

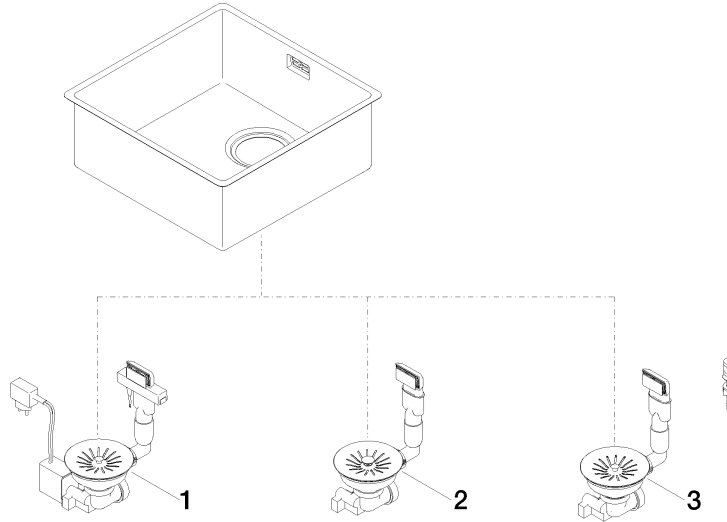

**Spare parts list**

No.	Item Number	Name	Quantity used	Delivery time
1	10 410 003-85	Pop-up waste and overflow with electronic control - Stainless Steel	1	2
2	10 400 003-85	Pop-up waste and overflow closable by hand - Stainless Steel	1	2
3	10 405 003-85	Pop-up waste and overflow with knob - Stainless Steel	1	2